

PDI 308 313 S

Inductive Proximity Sensors

Product image

Technical parameters

Nominal Sensing Distance Sn 30 mm	Effective Sensing Distance Sr 24 – 36 mm
Housing Dimensions M30	Mounting Non-Flush
Hysteresis (0,1 -0,15) x Sn	Nominal Voltage Un 24 VDC
Supply Voltage Uc 10 – 30 VDC	Supply Current Ic < 10 mA
Output Current Iz ? 200 mA	Switching Frequency 20 Hz
Short-Circuit Protection Yes	Polarity Reversal Protection Yes
Output Type PNP no	Housing Material Nickel Plated Brass
Ambient Temperature Range T -25°C...+70°C	Target Presence Indicator LED
Output Type Cable PVC 3 x 0,25 mm ²	Cable Length 2 m
Protection Standard IP 68	



Dimensions

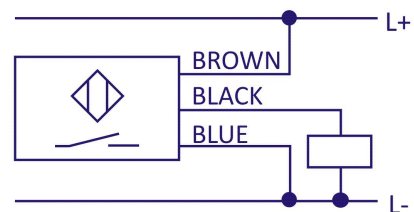
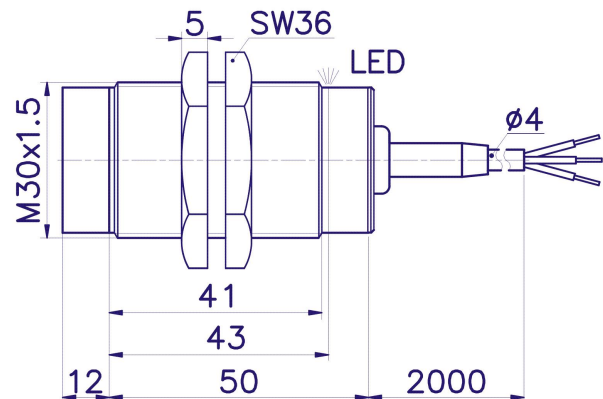

Company Head Office
PLOSKON AT s.r.o.
Jesenná 1
080 01 Prešov
Slovak Republic

Telephone
+421 / (0)51 7732 836
+421 / (0)51 7731 003

E-mail
obchod@ploskon.sk

Website
www.ploskon.sk

Billing information
PLOSKON AT s.r.o.
I?O:36483354
DI?:2020009860